

The Dispersion of Matter in Turbulent Flow through a Pipe

Geoffrey Taylor

Proc. R. Soc. Lond. A 1954 **223**, 446-468

doi: [10.1098/rspa.1954.0130](https://doi.org/10.1098/rspa.1954.0130)

References

Article cited in:

<http://rspa.royalsocietypublishing.org/content/223/1155/446#related-urls>

Email alerting service

Receive free email alerts when new articles cite this article - sign up in the box at the top right-hand corner of the article or click [here](#)

To subscribe to *Proc. R. Soc. Lond. A* go to:
<http://rspa.royalsocietypublishing.org/subscriptions>

The dispersion of matter in turbulent flow through a pipe

BY SIR GEOFFREY TAYLOR, F.R.S.

(Received 24 December 1953—Read 11 March 1954)

The dispersion of soluble matter introduced into a slow stream of solvent in a capillary tube can be described by means of a virtual coefficient of diffusion (Taylor 1953*a*) which represents the combined action of variation of velocity over the cross-section of the tube and molecular diffusion in a radial direction. The analogous problem of dispersion in turbulent flow can be solved in the same way. In that case the virtual coefficient of diffusion K is found to be $10 \cdot 1av_*$ or $K = 7 \cdot 14aU \sqrt{\gamma}$. Here a is the radius of the pipe, U is the mean flow velocity, γ is the resistance coefficient and v_* 'friction velocity'.

Experiments are described in which brine was injected into a straight $\frac{3}{8}$ in. pipe and the conductivity recorded at a point downstream. The theoretical prediction was verified with both smooth and very rough pipes. A small amount of curvature was found to increase the dispersion greatly.

When a fluid is forced into a pipe already full of another fluid with which it can mix, the interface spreads through a length S as it passes down the pipe. When the interface has moved through a distance X , theory leads to the formula $S^2 = 437aX(v_*/U)$. Good agreement is found when this prediction is compared with experiments made in long pipe lines in America.

1. INTRODUCTION

In a recent paper (Taylor 1953*a*) it was shown that when soluble material is injected into a tube through which a viscous fluid is flowing in stream-line motion it is dispersed, relative to a frame of reference which moves with the mean speed of flow, as though it were acted on by a virtual coefficient of diffusion K , where

$$K = \frac{a^2 U^2}{48D}, \quad (1.1)$$

Here a is the radius of the pipe, U the mean speed of flow, and D the coefficient of molecular diffusion of the injected material in the fluid.

The object of the present investigation is to find out whether an analogous treatment can be applied to dispersion in a fluid in turbulent flow.

This question has a practical interest because one of the methods used by engineers for measuring the flow in large water mains is to inject a packet of salt into the main at one point and to measure the electrical conductivity of the water at another point distant X downstream from the point of injection (Allen & E. A. Taylor 1923). If each element of the salt solution were carried down the fluid without diffusing radially, and if the electrode could be so arranged as to measure the mean concentration over a section, the conductivity would start to rise at the instant the maximum velocity u_0 in the middle of the pipe carried the salt to the measuring point. If this rise began at time T_0 after the injection, evidently $u_0 = X/T_0$. The subsequent course of the conductivity-time curve will depend on the initial distribution of salt at the moment of injection and on the distribution of velocity over the section of the pipe. To use the method for measuring the mean speed of flow, the point on the conductivity-time curve which corresponds to the time taken

The dispersion of matter in turbulent flow through a pipe 447

by a point moving with the mean speed of flow to cover the distance X must be determined. If this is T_m , the mean speed of flow is

$$U = X/T_m. \quad (1.2)$$

To use the method it is therefore essential to know how to pick out the instant T_m by inspection of the conductivity-time curve measured at the point X . This problem was solved empirically by Allen & Taylor (1923), who first developed this method, by measuring the rate of discharge, from their water main by other methods and observing the point on the conductivity-time curve which corresponded to time X/U . They found in this way that T_m corresponded to the instant at which the conductivity at X was a maximum. This empirical result could not have been obtained if the salt had been carried down the pipe in laminar flow without lateral turbulent diffusion. In such a case it is a simple matter to calculate the distribution of concentration which results from any given initial distribution. If, for instance, a mass M of salt is initially concentrated uniformly on the plane $x = 0$, the mean concentration (Taylor 1953*a*) at time t is uniform over a length $u_0 t$ of pipe, where u_0 is the maximum velocity in the centre of the pipe. Thus the mean concentration per unit volume is $C = \frac{M}{\pi a^2 u_0 t}$, where πa^2 is the area of cross-section of the pipe. The concentration-time curve at the section $x = X$ will therefore be represented by

$$\left. \begin{aligned} C &= 0 & (0 < t < X/u_0), \\ C &= \frac{M}{\pi a^2 u_0 t} & (t > X/u_0). \end{aligned} \right\} \quad (1.3)$$

The mean velocity in the pipe is $\frac{1}{2}u_0$, so that the point on the concentration-time curve which corresponds to the mean velocity is not that at which the concentration is a maximum, but that at which the concentration is only half its maximum value.

2. GENERAL CONSIDERATIONS ON DISPERSION IN TURBULENT FLOW THROUGH A PIPE

If a number of particles are released in uniform field of turbulence in which the mean velocity is zero, it has been shown (Taylor 1922) that the mean value of x^2 is

$$\overline{x^2} = 2\overline{u^2} \int_0^t \int_0^t R(\xi) d\xi dt, \quad (2.1)$$

where $R(\xi)$ is the correlation between the velocity u of a particle in the direction x at one instant, t_0 , and the velocity of the same particle at time $t_0 + \xi$. If ξ is sufficiently great $R(\xi)$ becomes zero and $\int_0^\infty R(\xi) d\xi$ is finite. In that case when t is very large

$$\overline{x^2} = 2\overline{u^2} t \int_0^\infty R(\xi) d\xi. \quad (2.2)$$

It was pointed out to me in private conversation with G. K. Batchelor, that the case of flow at constant speed through a long uniform pipe is one of the cases to which this analysis can legitimately be applied, but x in (2.2) must be replaced by

$x_1 = x - Ut$ and u by $u' = u - U$, U being the mean speed of flow. The mean-square deviation is then

$$\overline{x_1^2} = 2\overline{u'^2}t \int_0^\infty R(\xi) d\xi, \quad (2.3)$$

or, since $t = X/U$,

$$\overline{x_1^2} = 2\overline{u'^2}XU^{-1} \int_0^\infty R(\xi) d\xi. \quad (2.4)$$

Bearing in mind (a) that U is uniform along a uniform pipe and (b) that the correlation must disappear when X is sufficiently great, it seems that in a uniform pipe the spread, $\sqrt{\overline{x^2}}$, of an initially concentrated mass must increase as $X^{\frac{1}{2}}$. If, in any practical case, the spread is observed to increase in some other way than as $X^{\frac{1}{2}}$, this is a sure indication that the system considered is not simply a long straight pipe.

The spread of particles which diffuse in a random manner may also be described by the diffusion equation

$$\frac{\partial C}{\partial t} = K \frac{\partial^2 C}{\partial x_1^2}, \quad (2.5)$$

where K is a coefficient of diffusion and C is the concentration of the diffusing substance.

A solution of (2.5) is

$$C = At^{-\frac{1}{2}} e^{-x_1^2/4Kt}. \quad (2.6)$$

Here A is a constant depending on the total amount of diffusing material. To find $\overline{x_1^2}$ insert the value of C from (2.6) in

$$\overline{x_1^2} = \frac{\int_{-\infty}^{+\infty} x_1^2 \frac{dC}{dx_1} dx_1}{\int_{-\infty}^{+\infty} \frac{dC}{dx_1} dx_1}. \quad (2.7)$$

It is found that

$$x_1^2 = 4Kt,$$

and comparing this with (2.4)

$$K = \frac{1}{2}\overline{u'^2} \int_0^\infty R(\xi) d\xi. \quad (2.8)$$

3. BASIS OF THE PRESENT ANALYSIS

In the preceding paragraph it is shown that the dispersion of diffusible matter about a point which moves with the mean speed of flow can be regarded as being due to a virtual coefficient of diffusion K . The value of K has been expressed in (2.8) in terms of a correlation coefficient $R(\xi)$ which cannot be measured directly even though in a continuous field of flow it must exist.

The object of the analysis which follows is to predict the value of K and to show how it is connected with the previously measured quantities connected with turbulent flow in pipes.

Use of previous experimental results

Two experimental results are needed: (A) the distribution of velocity over the cross-section of a pipe and (B) the connexion between the transfer of momentum in turbulent flow and the transfer of other transferable properties.

The dispersion of matter in turbulent flow through a pipe

TABLE I

1	2	3	4	5	6	7	8	9	10	11
z	$f(z)$	$f'(z)$	$\int_0^z zf(z) dz$	$-\phi(z)$	$\frac{f'(z)}{z^2}$	$-\psi(z)$	$-\int_0^z \psi(z) dz$	$(z) - 4.25$	χ	$\int_0^z \chi dz$
0	0	0	0	0	—	0	0	-4.25	0	0
0.10	0.059	1.18	0.0001	0.0211	118	2.49	0.125	-4.19	+0.05	+0.012
0.20	0.236	2.36	0.0023	0.0827	58.5	4.83	0.491	-4.01	+0.39	+0.025
0.30	0.530	3.93	0.0120	0.1793	43.6	7.82	1.123	-3.72	+1.25	+0.107
0.35	0.750	4.81	0.0225	0.2379	39.4	9.37	1.553	-3.50	+1.90	+0.186
0.40	1.01	5.40	0.0367	0.3034	33.8	10.25	2.044	-3.24	+2.65	+0.300
0.45	1.29	6.10	0.0613	0.3691	30.2	11.15	2.579	-2.96	+3.34	+0.452
0.50	1.62	7.10	0.0960	0.4354	28.5	12.41	3.168	-2.63	+4.16	+0.642
0.55	2.00	8.00	0.1438	0.4992	26.4	13.18	3.807	-2.25	+4.71	+0.864
0.60	2.42	8.90	0.2076	0.5576	24.7	13.77	4.481	-1.83	+4.92	+1.105
0.65	2.89	9.80	0.2909	0.6072	23.2	14.09	5.178	-1.35	+4.58	+1.342
0.70	3.40	11.6	0.3975	0.6441	23.7	15.26	5.911	-0.85	+3.52	+1.544
0.75	4.05	14.0	0.5329	0.6628	24.9	16.50	6.706	-0.20	+1.01	+1.658
0.80	4.80	17.2	0.7049	0.6555	26.9	17.63	7.559	+0.55	-3.33	+1.600
0.85	5.79	21.0	0.9239	0.6119	29.0	17.74	8.443	+1.54	-11.05	+1.240
0.90	7.10	25.0	1.2069	0.5149	30.9	15.91	9.285	+2.85	-23.81	+0.368
0.92	7.66	31.2	1.3405	0.4587	36.9	16.93	9.613	+3.41	-30.16	-0.171
0.94	8.37	41.6	1.4897	0.3886	47.2	18.34	9.966	+4.12	-38.60	-0.859
0.96	9.36	62.5	1.6584	0.3006	67.7	20.35	10.353	+5.11	-50.79	-1.753
0.97	10.11	83.3	1.7461	0.2540	88.4	22.45	10.567	+5.86	-60.06	-2.307
0.98	11.12	125	1.8554	0.1861	130	24.19	10.800	+6.87	-72.71	-2.971
0.99	12.85	250	1.9727	0.1107	255	22.23	11.062	+8.60	-88.71	-3.758
1.00	∞	∞	2.1257	0	∞	∞	11.446	+ ∞	∞	-5.03

$$\chi = [f(z) - 4.25] \left[\int_0^z \psi(z) dz \right] [z].$$

(A) The 'universal' distribution of velocity in a pipe will be assumed. It has been well verified by experiment (Goldstein 1938, p. 336) that the velocity u at radius r in a pipe of diameter $2a$ is given by

$$\frac{u_0 - u}{v_*} = f(z), \quad (3.1)$$

where

$$z = r/a. \quad (3.2)$$

The function $f(z)$ is universal in the sense that it applies to all straight pipes with circular cross-section whether smooth or rough, provided the flow is fully turbulent. u_0 is the velocity at the centre of the pipe and

$$v_* = (\tau_0/\rho)^{\frac{1}{2}}, \quad (3.3)$$

where τ_0 is the friction stress exerted by the turbulent fluid of density ρ on the wall.

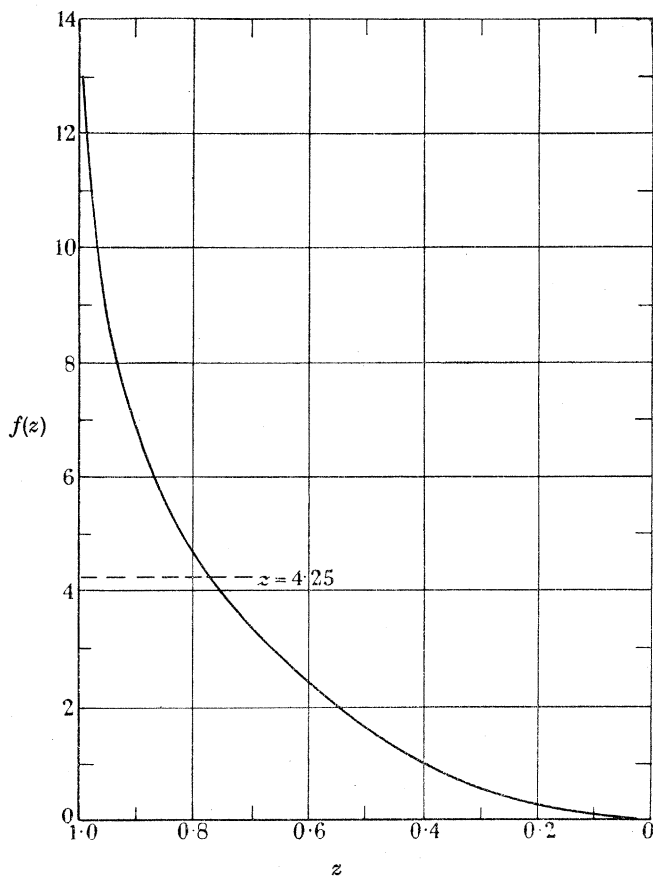

FIGURE 1

The function $f(z)$ has been determined by several workers. The values used in the present work are derived from a mean curve using measurements made by Stanton & Pannell (1914) and by Nikuradse (1932). They conform to von Karman's logarithmic law near the wall. They are given in column 2 of table 1 and are displayed in figure 1.

The dispersion of matter in turbulent flow through a pipe 451

(B) Reynolds's analogy will be assumed to be true. According to this assumption the transfer of matter, heat and momentum by turbulence are exactly analogous. If ϵ is the coefficient of transfer, Reynolds's analogy may be expressed in the present case by the equations

$$\epsilon = \frac{\tau}{\rho \frac{\partial u}{\partial r}} = \frac{m}{\frac{\partial C}{\partial r}}. \quad (3.4)$$

Here τ is the shear stress at radius r , m is the rate of radial transfer of matter of concentration C .

Reynolds's analogy has been experimentally verified as being nearly true in turbulent flow near a solid surface. It is not quite true for diffusion in free turbulence such as that behind an obstacle placed in a wind stream. Experiments in which air flows through heated pipes seem to show that Reynolds's analogy may safely be applied to turbulent pipe flow.

From (3.1) the mean velocity U may be found:

$$U = 2 \int_0^1 uz \, dz = u_0 - 2v_* \int_0^1 zf(z) \, dz. \quad (3.5)$$

Using values of $f(z)$ given in column 2, table 1, the values of $\int_0^z zf(z) \, dz$ given in column 4, table 1, were estimated by linear interpolation. Near $z = 1$ this method becomes inaccurate because according to von Karman's logarithmic law $f(z) \rightarrow \infty$ as $z \rightarrow 1$. In fact the values of $f(z)$ in the interval $0.9 < z < 1$ have been taken as

$$f(z) = \text{constant} - 2.5 \ln(1 - z), \quad (3.6)$$

and the constant was chosen so that $f(z)$ is continuous at $z = 0.9$, where its value is 7.1. Since $7.1 + 2.5 \ln(0.1) = 1.35$,

$$f(z) = 1.35 - 2.5 \ln(1 - z) \quad \text{when} \quad 0.9 < z < 1. \quad (3.7)$$

The figures in column 4, table 1 for $0.9 < z < 1$ were obtained by integrating (3.7). The last figure in column 4, table 1, is 2.125, so that from (3.5)

$$U = u_0 - 4.25v_*. \quad (3.8)$$

Some values previously given for $u_0 - U$ were $4.07v_*$ (Nikuradse) and $4.7v_*$ (Stanton) (Goldstein 1938, p. 339).

4. MECHANICS OF DISPERSION IN TURBULENT FLOW

In a circular pipe the transfer coefficient ϵ can be derived without assumption because the turbulent stress τ at radius r is related to τ_0 by the equation

$$\tau = \tau_0 z^{-1}, \quad (4.1)$$

so that from (3.4) and (3.1)

$$\epsilon = azv_* |f'(z)|, \quad (4.2)$$

where $f'(z)$ is written for $\frac{d}{dz}f(z)$. Using Reynolds's analogy, the equation for conservation of C is

$$\frac{\partial}{\partial r} \left(\epsilon r \frac{\partial C}{\partial r} \right) = r \left(u \frac{\partial C}{\partial x} + \frac{\partial C}{\partial t} \right). \quad (4.3)$$

Substituting for ϵ from (4.2), (4.3) becomes

$$\frac{\partial}{\partial z} \left(\frac{z^2}{f'(z)} \frac{\partial C}{\partial r} \right) = z \left\{ \left(f(z) - \frac{u_0}{v_*} \right) a \frac{\partial C}{\partial x} + \frac{a}{v_*} \frac{\partial C}{\partial t} \right\}. \quad (4.4)$$

Here x is measured along the pipe from a fixed point. It is convenient to use axes which move with the mean speed of flow. Thus the new co-ordinate x_1 is defined by

$$x = x_1 + Ut, \quad (4.5)$$

and (4.4) becomes

$$\frac{\partial}{\partial z} \left(\frac{z^2}{f'(z)} \frac{\partial C}{\partial z} \right) = z \left\{ \left(f(z) - 4.25 \right) \frac{\partial C}{\partial x_1} + \frac{a}{v_*} \left(\frac{\partial C}{\partial t} \right)_1 \right\}, \quad (4.6)$$

where

$$\left(\frac{\partial C}{\partial t} \right)_1 = \frac{\partial C}{\partial t} + U \frac{\partial C}{\partial x} \quad (4.7)$$

is the rate of change of C at a point which moves with velocity U .

First we may seek the solution of (4.6) for the case when $\partial C/\partial x$ is independent of x and z , and $\partial C/\partial t_1 = 0$. C is then of the form

$$C = C_{x_1} + C_z, \quad (4.8)$$

where C_{x_1} is independent of z but varies linearly with x_1 and C_z is independent of x_1 .

Equation (4.6) can then be solved. Writing

$$\phi(z) = \int_0^z (f(z) - 4.25) z \, dz \quad (4.9)$$

so that ϕ is negative,

$$\frac{\partial C_z}{\partial z} = \frac{f'(z)}{z^2} \phi(z), \quad (4.10)$$

so that if

$$\psi(z) = \frac{f'(z)}{z^2} \phi(z), \quad (4.11)$$

$$C_z = a \frac{dC_{x_1}}{dx_1} \int_0^z \psi(z) \, dz. \quad (4.12)$$

C_z is therefore negative when dC_1/dx_1 is positive. Values of $-\int_0^z \psi(z) \, dz$ are given in column 8, table 1. The rate of transfer of C across a section can now be calculated; it is

$$Q = 2\pi a^2 v_* \int_0^1 \chi(z) \left(a \frac{dC_{x_1}}{dx_1} \right), \quad (4.13)$$

where

$$\chi(z) = z(f(z) - 4.25) \left(\int_0^z \psi(z) \, dz \right). \quad (4.14)$$

Values of $-\phi(z)$ and $-\psi(z)$ are given in columns 5 and 7 to table 1, and values of $\chi(z)$ and $\int_0^z \chi(z) \, dz$ in columns 10 and 11. It will be seen that the last figure in column 11 is -5.03 , so that

$$Q = -10.06\pi a^3 v_* \frac{dC_{x_1}}{dx_1}. \quad (4.15)$$

The dispersion of matter in turbulent flow through a pipe 453

A virtual coefficient of diffusion K would transfer matter across a section at rate $-K\pi a^2 \frac{dC_{x_1}}{dx_1}$, so that matter is transferred across planes which move with the mean speed of flow as though it were being dispersed by a virtual coefficient of diffusion

$$K = 10.06av_*. \quad (4.16)$$

Estimate of the effect of longitudinal component in turbulent diffusion

In general it is found in turbulent systems that there is a strong tendency to isotropy. To estimate the order of the effect of longitudinal turbulent diffusion on the longitudinal dispersion it is sufficient to assume that the coefficient of longitudinal diffusion is equal to ϵ , the coefficient of lateral diffusion. The rate of transfer of matter across a plane owing to longitudinal diffusion is therefore

$$Q' = \int_0^a 2\pi r \epsilon \frac{dC}{dx} dr = 2\pi a^2 \frac{dC}{dx} \int_0^1 \epsilon z dz,$$

and from (4.2)

$$\epsilon = av_* z / f'(z),$$

so that

$$Q' = 2\pi a^3 v_* \frac{dC}{dx} \int_0^1 \frac{z^2}{f'(z)} dz. \quad (4.17)$$

Using the figures in column 6 of table 1 for $f'(z)/z^2$ the value of $\int_0^1 \frac{z^2}{f'(z)} dz$ was found to be 0.026, so that the mean coefficient of diffusion due to the longitudinal components of turbulent velocity is

$$K' = \frac{Q'}{\pi a^2 \frac{dC}{dx}} = 0.052av_*. \quad (4.18)$$

This is small compared with K , but it is additive, so that the corrected value of K allowing for longitudinal diffusion is

$$K = (10.06 + 0.05)av_* = 10.1av_*. \quad (4.19)$$

An expression for K equivalent to (4.18) was found by Worster (1952). He noted that it is of order $\frac{1}{100}$ th of the value necessary to account for the dispersion observed in pipe lines. He suggested that an expression analogous to (4.18), but with the numerical factor increased about 100-fold might be used as a 'working formula' for predicting dispersion. It will be seen that there is a good theoretical basis for this suggestion. The formula (4.19) was given earlier (Taylor 1953*b*) without proof and with the factor 8.98 instead of 10.1.

5. U/v_* AS FUNCTION OF R FOR SMOOTH PIPES

In applying the formula (4.19) to predict the dispersion in a tube it is convenient to write it in the form

$$K = 10.1aU \left(\frac{v_*}{U} \right). \quad (5.1)$$

For smooth pipes v_*/U depends only on the Reynolds number. By definition $\frac{v_*}{U} = \frac{1}{U} \sqrt{\frac{\tau_0}{\rho}}$. The coefficient γ , which is usually used to express the results of experiments or friction in pipes, is defined by

$$\tau_0 = \frac{1}{2} \gamma \rho U^2, \quad (5.2)$$

so that

$$\frac{v_*}{U} = \sqrt{\left(\frac{1}{2}\gamma\right)}. \quad (5.3)$$

TABLE 2

U/v_*	$\log_{10} R$	R	U/v_*	$\log_{10} R$	R
12	3.150	1.41×10^3	22	5.181	1.52×10^5
13	3.361	2.30×10^3	23	5.378	2.39×10^5
14	3.570	3.72×10^3	24	5.573	3.74×10^5
15	3.777	5.99×10^3	25	5.767	5.85×10^5
16	3.982	9.60×10^3	26	5.961	9.15×10^5
17	4.185	1.53×10^4	27	6.157	1.44×10^6
18	4.387	2.44×10^4	28	6.347	2.22×10^6
19	4.587	3.86×10^4	29	6.550	3.55×10^6
20	4.786	6.11×10^4	30	6.731	5.38×10^6
21	4.984	9.64×10^4			

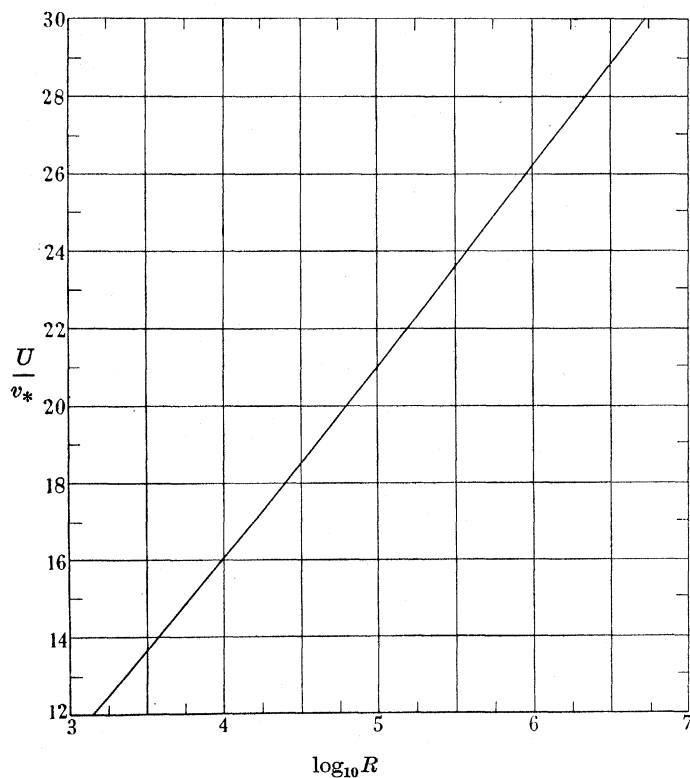

FIGURE 2

The dispersion of matter in turbulent flow through a pipe 455

The relationship between γ and the Reynolds number $R = 2aU/\nu$ may be expressed by the equation (Goldstein 1938, p. 338, eq. (19))

$$\gamma^{-\frac{1}{2}} = -0.40 + 4.00 \log_{10} R + 2.00 \log_{10} \gamma. \quad (5.4)$$

From this equation the value of R corresponding to any given value of γ can be found.

To facilitate the application of (5.1) to actual pipes the values of R corresponding to integral values of U/v_* from 12 to 30 were calculated using (5.4). They are given in table 2 and are displayed in figure 2. It will be seen that when R is plotted logarithmically the curve is very nearly, but not quite, a straight line.

6. PREDICTED DISTRIBUTION OF CONCENTRATION OF MATERIAL INITIALLY CONCENTRATED AT $x = 0$ AT TIME $t = 0$

Since the centre of the diffused material at time t is at $x = Ut$ the distribution of concentration at time t is

$$C = At^{-\frac{1}{2}} \exp \left[\frac{-(x - Ut)^2}{4Kt} \right] \quad (6.1)$$

at a time t the distribution is symmetrical and Gaussian. It is centred on the point $X = Ut$. It will be seen, however, that when measurements are made at a fixed point x , the concentration-time curve is not symmetrical. The lack of symmetry, however, is small when Ut is much greater than $\sqrt{(4Kt)}$, and taking $K = 10.1av_*$, $X = Ut$ this gives as the condition that the asymmetry inherent in (6.1) shall be small,

$$\frac{X}{a} \gg \frac{40v_*}{U}. \quad (6.2)$$

In most cases U/v_* is of order 15, so that at distances down stream greater than say 100 diameters the asymmetry of the concentration-time curve may be expected to be small. This expectation is not verified however when the Reynolds number is so low that the laminar boundary layer may contain an appreciable quantity of the diffusing material. In such cases the material is only released slowly by molecular diffusion and may give rise to a long 'tail' in the concentration-time curve.

7. COMPARISON WITH OBSERVATIONS

Allen & Taylor (1923) injected salt into a stream of water flowing through a pipe 40 in. in diameter and 355 ft. long. They measured the changes in conductivity at the outlet end. Their results for a number of experiments when the speed of flow was 3.45 ft./s, or 105 cm/s are shown in figure 3, which is reproduced from their paper. It will be seen that the maximum conductivity occurred 103 s after injecting the salt at the other end of the pipe. The conductivity-time curves seem to be nearly symmetrical. The length of time during which the conductivity was greater than half its maximum value was measured in each case and was found to be $15\frac{1}{2}$, $13\frac{1}{2}$, 17 and 14 s. The mean is 15 s. The mean length of pipe containing fluid of concentration greater than half the maximum may be defined as $2x_{\frac{1}{2}}$, so that in the observations under consideration

$$2x_{\frac{1}{2}} = 15 \times 105 = 1575 \text{ cm.}$$

If the curves of figure 3 were accurately Gaussian, K would be derived from the formula

$$\frac{x_{\frac{1}{2}}^2}{4Kt} = \ln 2 = 0.693, \quad (7.1)$$

so that
$$K = \frac{(1575)^2}{16(103)(0.693)} = 2.18 \times 10^3 \text{ cm}^2 \text{ s}^{-1}. \quad (7.2)$$

Taking the dynamical viscosity, ν for water at normal temperatures as 0.011, and $U = 105 \text{ cm/s}$, the value of R is 0.97×10^6 , so that $\log_{10} R = 5.987$. From figure 2 this value of $\log_{10} R$ corresponds to $U/v_* = 26.0$. The value for a rough pipe would be less.

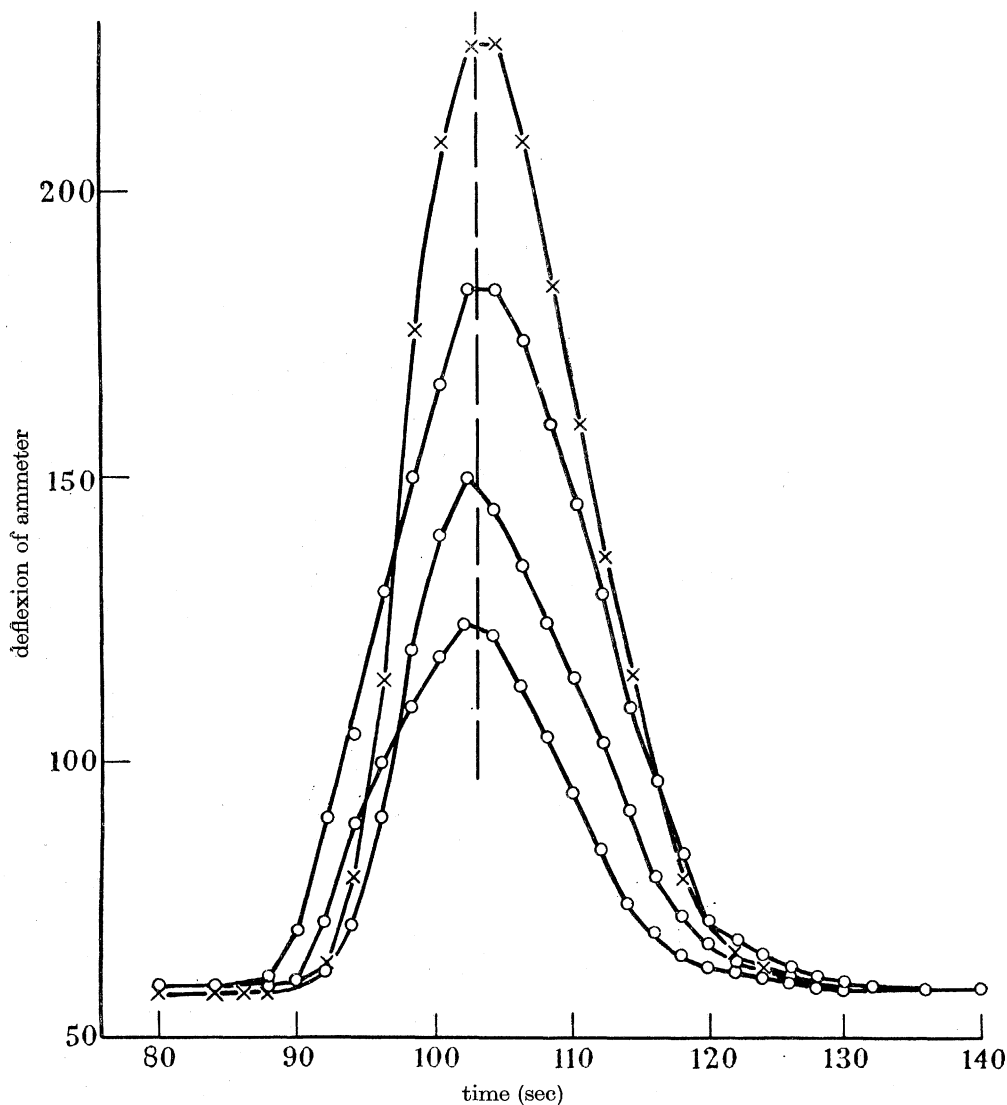

FIGURE 3. Allen & Taylor's measurements in a 40 in. pipe 355 ft. long. Salt charge, $\frac{1}{2}$ sec; 4 in. electrode at centre of pipe; timing by metronome and stopwatch; readings every 2 sec; the broken vertical line indicates the mean time from Q by weir.

The dispersion of matter in turbulent flow through a pipe 457

To compare observed values of dispersion with those calculated using (5.1) it is convenient to divide the observed value of K by av_* or $aU(v_*/U)$. If the theory were exactly true, (5.1) shows that this number would be 10.1. In Allen & Taylor's experiments, displayed in figure 3,

$$\frac{K}{aU} \left(\frac{U}{v_*} \right) = \frac{2.18 \times 10^3}{(20 \times 2.54)(105)} (26.0) = 10.6. \quad (7.3)$$

The closeness of the agreement between this value 10.6 and the theoretical value 10.1 is partly accidental, for in another set of measurements made in the same pipe by the same authors at a lower speed gave the value 11.7 when analyzed in the same way.

8. EXPERIMENTS AT THE CAVENDISH LABORATORY

Smooth pipes

The method used in the experiments of Allen & Taylor (1923), though admirably adapted to the purpose for which it was intended, was not sufficiently refined to give entirely reliable information on dispersion, and the pipe length, 106 diameters, was too small for valid application of the theory. The experiments of Hull & Kent,

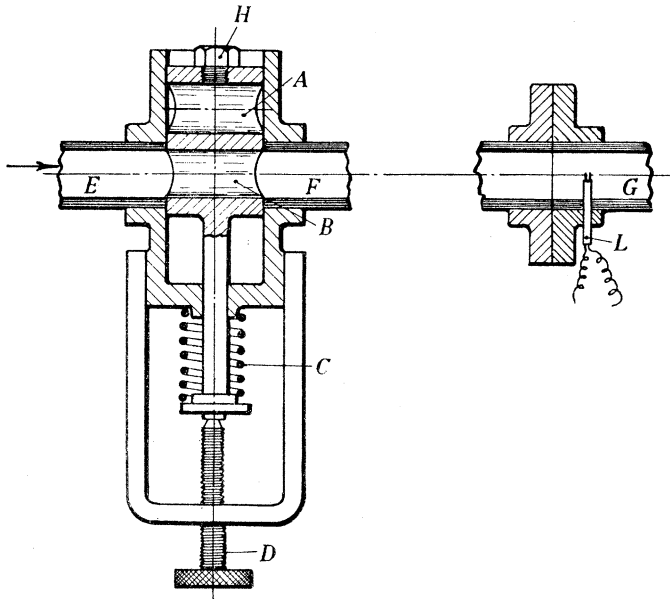

FIGURE 4. Part of apparatus for measuring dispersion of brine.

to be described later, were not made with an unobstructed straight pipe, so that they are not quite suitable for comparison with the theory. It seemed worth while therefore to set up a straight pipe in the laboratory and measure the concentration-time curve down stream of a point where salt was injected. Part of the apparatus is sketched in figure 4. A stainless steel pipe EFG was laid on a straight bed. Water from a tank in the roof of the laboratory was run through the pipe and the flow measured by

means of a calibrated bucket. To ensure that the salt was introduced very rapidly and without affecting the flow, the spring piston shown in figure 4 was made. This piston had two transverse holes, A and B , each $\frac{3}{8}$ in. diameter and separated by about $\frac{1}{10}$ in. The spring C was compressed by means of the screw D until a catch (not shown) fixed the piston in the position shown in figure 4 where the lower hole B formed a continuous portion of the main pipe EFG . The screw D was then lowered so that when the catch was released the piston would spring down to a position where the hole A was in line with the pipe. In performing an experiment the brine was introduced at the hole H in the top of the piston so that the hole A was filled with it. This method made it possible to introduce the salt suddenly with very little disturbance to the flow.

The first experiments were made with a $\frac{3}{8}$ in. pipe 0.952 cm internal diameter and 480 cm long. Small two-point electrodes were placed at distances $X = 15$ and $X = 468$ cm from the piston. These were supplied with alternating current at 2000 c/s and connected to a double-beam oscillograph so that the deflexions of the beams were expected to be proportional to conductivity of the fluid passing the electrodes. The screen of the oscillograph was projected on to a photographic film fixed to a rotating drum. Figure 5 shows a record taken at $U = 213$ cm/s in which the conductivity at $X = 15$ and at 464 cm are shown. The upper trace in figure 5 is a time mark made by connecting a 50-cycle tuning fork to the second beam of the oscillograph. When the trace for 464 cm was measured it was found to be rather unsymmetrical. It was also found to differ from an error curve in being too wide at half concentration compared with the width at quarter concentration. It was suspected, and afterwards verified, that the oscillograph beam was not recording the concentration on a linear scale. This defect would distort a true error law distribution into one resembling that shown in figure 5.

In an attempt to overcome these defects a new pipe 1650 cm long was fixed to a straight bed. Electrodes were placed at three points, 13, 332 and 1631 cm from the piston.

Experiments were made at two speeds, 222 and 136/cm/s. Figure 6 shows the time variation of concentration at 1631 cm and figure 7 at 322 cm during the faster run. It will be seen that at 1631 cm when $t = 7.34$ s the distribution is nearly symmetrical, but at 322 cm when $t = 1.45$ s it is not quite so symmetrical. The period during which the concentration was greater than half the maximum was found by measuring figures 6 and 7. It was 0.316 s at $X = 1631$ cm and 0.151 s at 322 cm. These correspond with distances

$$2x_{\frac{1}{2}} = 222(0.316) = 70.1 \text{ cm at } X = 1631$$

and

$$2x_{\frac{1}{2}} = (222)(0.151) = 33.5 \text{ cm at } X = 322.$$

The corresponding values of K are:

$$\text{at } 1631 \text{ cm, } K = \frac{[\frac{1}{2}(70.1)]^2}{4(0.693)(7.34)} = 60.4 \text{ cm}^2\text{s}^{-1},$$

$$\text{and at } 322 \text{ cm, } K = \frac{[\frac{1}{2}(33.5)]^2}{4(0.693)(1.45)} = 70.0 \text{ cm}^2\text{s}^{-1}.$$

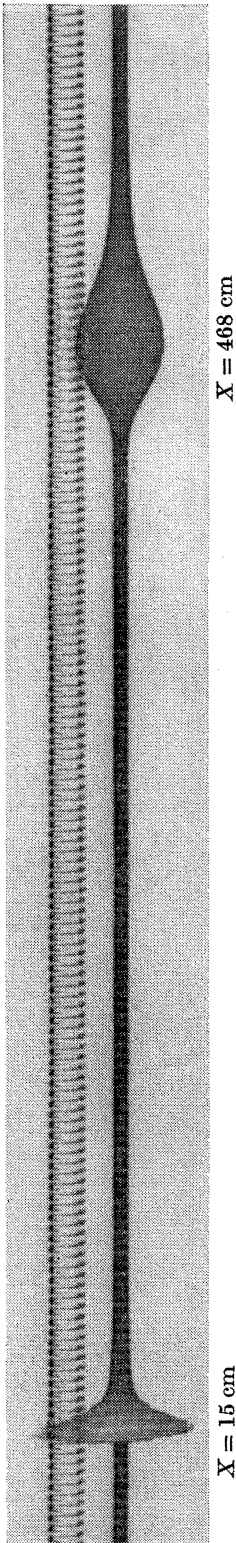

FIGURE 5. Record showing pulse at $X = 15$ and at 468 cm.

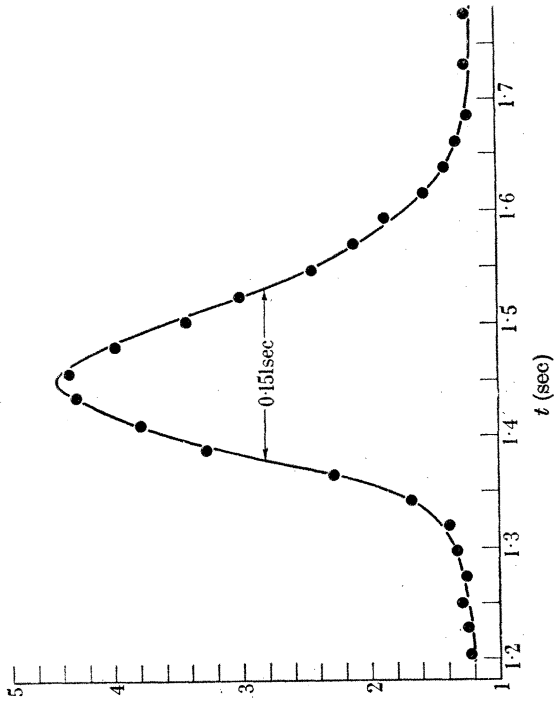

FIGURE 7. Pulse at $X = 322$ cm, $U = 222$ cm/s.
Less symmetrical than at 1631 cm.

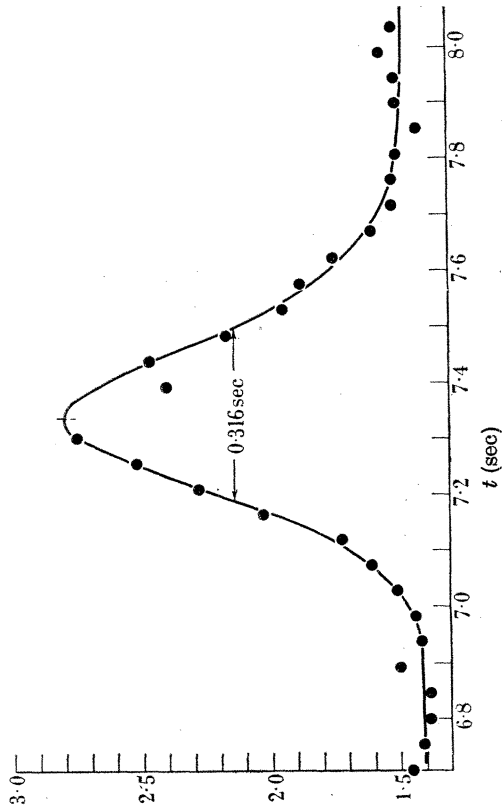

FIGURE 6. Pulse at $X = 1631$ cm, $U = 222$ cm/s, $R = 1.9 \times 10^4$.

The internal diameter of the pipe was 0.9525 cm, so that

$$R = \frac{(0.9525)(222)}{0.011} = 1.93 \times 10^4,$$

and using figure 2 this corresponds to $U/v_* = 17.5$. Thus at $X = 1631$ cm

$$\frac{K}{av_*} = \frac{(60.4)(17.5)}{(0.476)(222)} = 10.0;$$

at $X = 322$ cm,

$$\frac{K}{av_*} = \frac{(70.0)(17.5)}{(0.476)(222)} = 11.6.$$

The theoretical value is 10.1, so that at $X = 1631$ cm the dispersion is very close indeed to the theoretical value. At $X = 322$ the spread of the salt is a little greater than theory predicts.

Figure 8 shows the time variation of C at the lower speed 136 cm/s. It will be seen that the curve is not at all Gaussian. It is noticeably steeper at the front than the rear. This characteristic shows slightly in figure 7 for $U = 222$ cm/s at $X = 322$, but

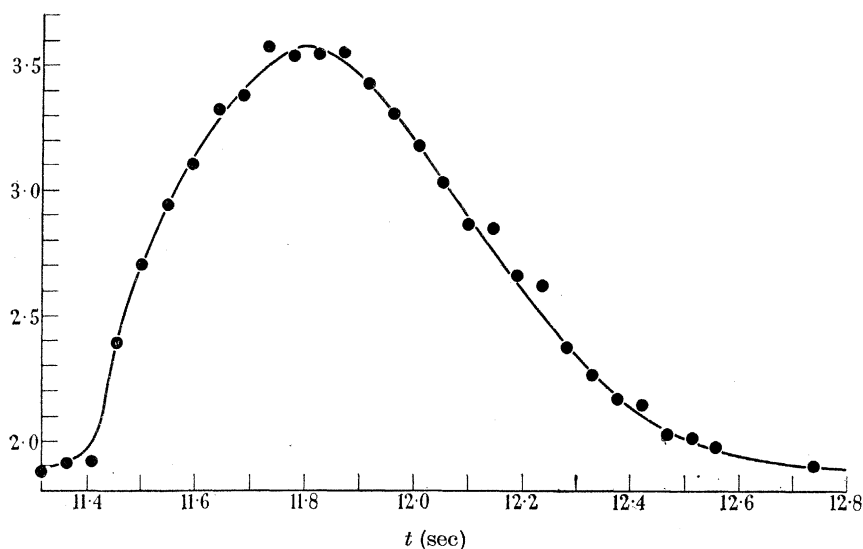

FIGURE 8. Pulse at $X = 1631$, $U = 136$ cm/s, $R = 1.2 \times 10^4$.

is less noticeable at $X = 1631$. It seems that at $U = 136$ cm/s, when $R = 1.18 \times 10^4$, the distribution has not yet become Gaussian at $X = 1631$ cm. The reason for this is no doubt that the laminar part of the boundary layer is rather thick at $R = 1.18 \times 10^4$, and the loss of salt by molecular diffusion from that layer takes longer than in the case where R is higher. Measuring the curve of figure 8 it is found that $x_{\frac{1}{2}} = 82.8$ cm, $t = 12$ s, so that $K = 51.3$ cm²/s. Hence

$$\frac{K}{av_*} = \frac{(51.3)(16.1)}{(0.476)(136)} = 12.8.$$

The dispersion of matter in turbulent flow through a pipe 461*Rough pipes*

The universal distribution of velocity represented by (3.1) applies to rough pipes as well as smooth ones. It might therefore be expected that the dispersive power of rough pipes would also be represented by (4.19). To test this prediction a piece of $\frac{3}{8}$ in. pipe 247.3 cm long was artificially roughened and fitted to the piston at *F* (figure 4). To roughen the pipe a plastic adhesive Araldite, which was kindly supplied by Dr de Bruyne of Aeroresearch Ltd, was mixed with toluene and the inner surface of the tube wetted with the mixture. After draining and leaving for a time to get tacky, dry sand which could pass a sieve of mesh 20/in. but be retained by a sieve of mesh 30/in., was poured through the tube till dry sand came out of the far end. A cylindrical piece of brass $\frac{1}{4}$ in. diameter was then pulled through the $\frac{3}{8}$ in. tube, thus ensuring that no sand projected more than $\frac{1}{16}$ in. from the wall. The resistance of this tube was determined by measuring the time necessary to fill a calibrated bucket and at the same time measuring the pressure difference between the ends of the roughened section.

To find the mean velocity it was first necessary to find the mean diameter of the pipe. This was done by filling it with water and weighing. The weight of water was 161.3 g, so that the area of cross-section was $161.3/247.3 = 0.652$ cm². The mean radius was therefore $a = \pi^{-\frac{1}{2}}(0.652)^{\frac{1}{2}} = 0.455$ cm. In a run which filled 8.0 l. in 84 s, $U = \frac{8 \times 10^3}{(84)(0.652)} = 146$ cm/s. The pressure difference between pressure holes 245 cm apart was that due to 41.1 cm of mercury in a mercury-water manometer. The pressure fall in 245 cm was therefore

$$(41.1) \times (13.6 - 1)(981) = 5.076 \times 10^5 \text{ dynes/cm}^2.$$

The friction stress τ_0 was

$$\tau_0 = \frac{1}{2}a \frac{dp}{dx} = \frac{(0.455)(5.076 \times 10^5)}{2 \times 245} = 4.71 \times 10^2 \text{ dynes/cm}^2.$$

In this case therefore since

$$v_* = (471)^{\frac{1}{2}} = 21.7 \text{ cm/s}, \quad (8.1)$$

and

$$\frac{U}{v_*} = \frac{146}{21.7} = 6.73.$$

The concentration-time record obtained in this experiment is shown in figure 9, and the result of measuring it shown in figure 10. It will be seen that the distribution of salt is very nearly symmetrical. The points do not quite fall on a smooth curve. This might be expected from an inspection of figure 9. The waviness of the record is due to a small amount of the 50-cycle fluctuation in the electric supply. This fluctuation would not matter if the spot of the cathode-ray oscillograph moved exactly in a vertical line, but it is difficult with a double-beam instrument to ensure that this always happens, and as will be seen there is a difference in phase between the waviness of the upper and lower edges of the trace. This gives rise to a small periodic variation in measurements of the width of the record. The ordinates in

figure 10 represent the difference between the width of the record before and after the arrival of the salt at the electrode.

When $U = 146$ cm/s the dispersive power of the smooth pipe may be expected to be less than that of the rough pipe in the ratio $\frac{v_*(\text{smooth})}{v_*(\text{rough})} = \frac{6.75}{17} = 0.4$. Thus the 12 cm of smooth pipe may be taken as equivalent to 5 cm of rough pipe. For this

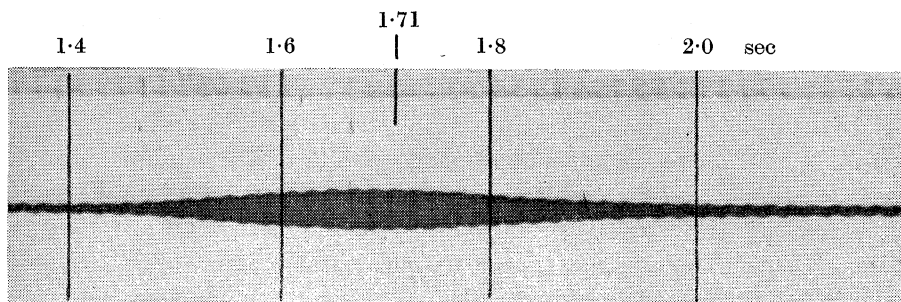

FIGURE 9. Record of pulse in a very rough pipe, $U = 146$ cm/s.

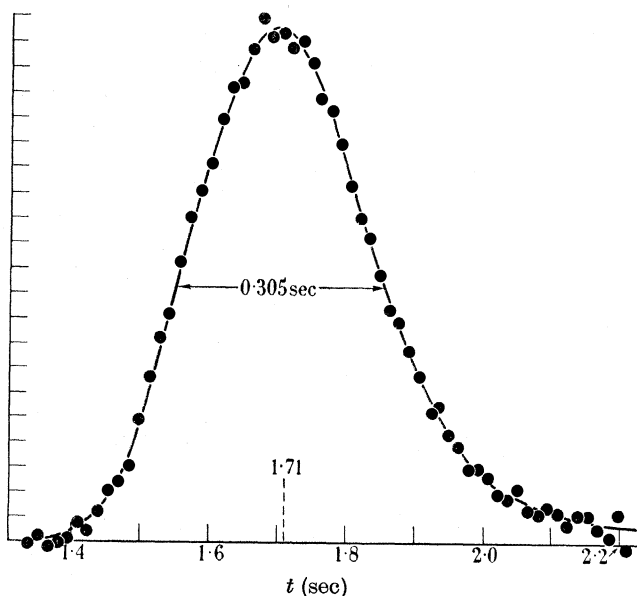

FIGURE 10. Concentration-time curve from the record of figure 9.

reason it was thought best to take the instant when the salt entered the rough section as the $t = 0$ rather than the instant of injection of the salt. The time scales of figures 9 and 10 were obtained by counting the 50-cycle marks from the instant the salt began to pass the first electrode. The electrodes were just outside the roughened length 250 cm apart. The time taken for a point moving at the mean speed, 146 cm/s to traverse 250 cm is 1.71 s, this point is marked in figures 9 and 10. It will be seen that the maximum concentration is attained only a very short time before this.

The dispersion of matter in turbulent flow through a pipe 463*Measurement of K from record and comparison with theory*

The length of time during which the concentration is greater than half its maximum value is marked in figure 10. It is 0.305 s. This corresponds to a length $0.305 \times 146 = 44.54$ cm. From (7.1), therefore,

$$K = \frac{(22.27)^2}{4(0.693)(1.71)} = 1.04 \times 10^2.$$

The value of $\frac{K}{av_*}$ is therefore $\frac{1.04 \times 10^2}{(0.455)(21.7)} = 10.5$. This is close to the theoretical value 10.1, so that it appears that the theoretical formula (4.19) applies even with a very rough pipe.

Experiments with a curved pipe

The universal distribution of velocity in a straight pipe applies to rough as well as smooth ones, but it no longer applies if they are curved. The large-scale pipes used for conveying oil or water across the country have to accommodate themselves to the surface on which they are laid. In most cases therefore they cannot be straight. In comparing laboratory experiments with observations made in large pipe lines it is necessary to know the effect of curvature of the centre line on the dispersive power of a fluid flowing through a pipe. For this reason a $\frac{3}{8}$ in. pipe was bent into a circle approximately 3 ft. in diameter and fitted to the charging piston (see figure 4). The circumference of the pipe was 284 cm and at each end there were straight sections which brought the length between pressure measuring holes to 324 cm. Two measurements were made: (a) at $U = 113$ cm/s, (b) at $U = 202$ cm/s; the results are summarized in table 3, and those for straight pipes are given for

TABLE 3. COMPARISON WITH THEORETICAL VALUE $K/av_* = 10.1$

Pipe	U (cm/s)	R	U/v_*	K/av_*
40 in. (Allen & Taylor)	105	9.7×10^5	26.0	10.6
$\frac{3}{8}$ in. smooth, $X = 322$	222	1.9×10^4	17.5	11.6
$\frac{3}{8}$ in. smooth, $X = 1631$	222	1.9×10^4	17.5	10.0
$\frac{3}{8}$ in. smooth, $X = 1631$	136	1.2×10^4	16.1	12.8
$\frac{3}{8}$ in. rough, $X = 245$	146	1.3×10^4	6.73	10.5
$\frac{3}{8}$ in. curved, $X = 250$ (a)	113	1.7×10^4	15.0	21.9
$\frac{3}{8}$ in. curved, $X = 250$ (b)	202	1.7×10^4	16.1	15.0

Note. The values of U/v_* for the curved pipe were measured. The values for a straight pipe from figure 2 are: (a) 16.0 instead of 15 and (b) 17.1 instead of 16.1, so that the resistance coefficient is very little increased by curvature.

comparison. It will be seen that when the radius of curvature of the centre line of the pipe is 96 times the radius of the cross-section the value of K/av_* is much greater than it is for a straight pipe, even though the resistance coefficient is very little increased by this amount of curvature.

9. SPREAD OF RADIOACTIVE TRACER IN PIPE LINE

Hull & Kent (1952) injected a radioactive tracer into a 10 in. pipe line 182 miles long through which crude oil was flowing at 2.68 ft./s. They found that the curves representing concentration of the tracer against time at all stations in this pipe

were very nearly Gaussian error curves. Some of these are here reproduced in figure 11. The time, $2t_{\frac{1}{2}}$, during which the concentration at various intermediate stations was greater than half the maximum concentration were measured and the value of K deduced from the expression

$$K = \frac{U^3 t_{\frac{1}{2}}^2}{4X \ln 2}. \quad (9.1)$$

Here X is the length of pipe from the point of injection to the point of observation. The mean speed of flow was 81.7 cm/s. The values of K found are given in table 4.

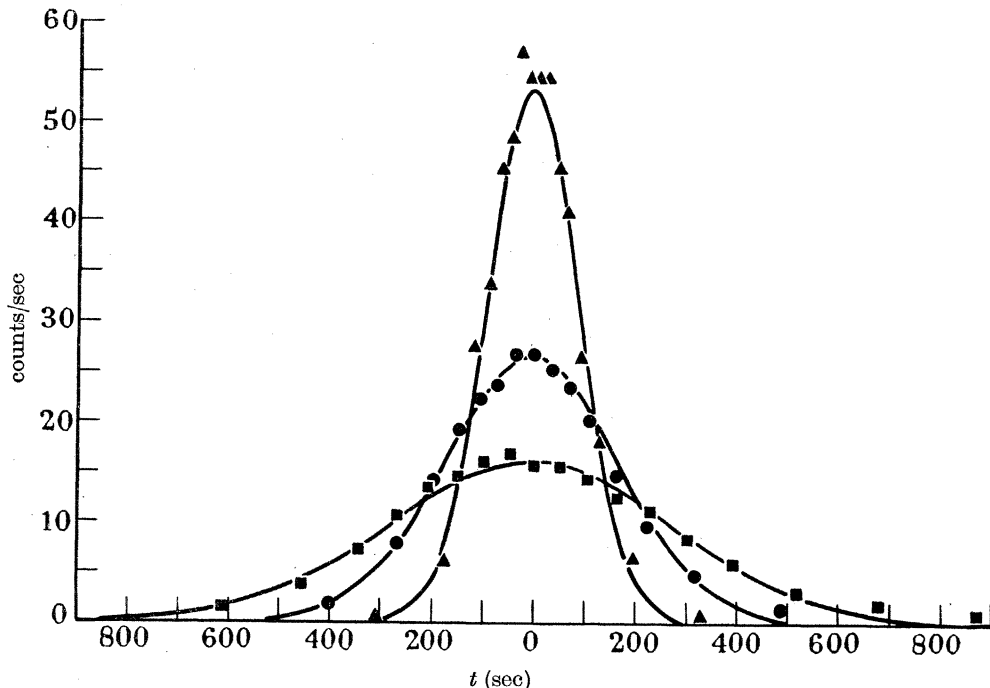

FIGURE 11. Hull & Kent's experiment. Observation stations: \blacktriangle Bonanza (13.8 miles); \bullet Green River (43.1 miles); \blacksquare Hanna (108.5 miles).

TABLE 4. DISPERSION OF A POINT SOURCE IN A 10 IN. PIPE 182 MILES LONG FROM RANGELY TO SALT LAKE

X (miles)	1.9	13.8	43.1	108.5	125	130.2	182.5
$2t_{\frac{1}{2}}$ (s)	67	211	402	669	746	770	895
K (cm^2s^{-1})	718	980	1140	1150	1350	1380	1330
K/av_*	12.3	16.9	19.3	20.0	22.8	23.4	22.5

The Reynolds numbers were between 21500 and 27000.

For $R = 24000$, figure 2 gives $U/v_* = 17.9$. The values of K/av_* are given in the last row of table 4.

It will be seen that only at $X = 1.9$ miles was the dispersion at all close to the theoretical value represented by $K/av_* = 10.1$. This may well be due to the existence of bends which, as was shown in § 8, would necessarily increase the dispersion above what would occur in a straight unobstructed pipe. That this may well be the cause

The dispersion of matter in turbulent flow through a pipe 465

of the discrepancy can be inferred from the fact that the observed dispersion increases as $X^{0.56}$ instead of increasing as $X^{\frac{1}{2}}$. In a straight pipe it seems certain that the dispersion must increase proportionally to $X^{\frac{1}{2}}$.

Hull & Kent (1952) give two more results. In the 8 in. pipe line from El Segundo to Montebello $U = 3.61$ ft/s = 110 cm/s, $R = 3.0 \times 10^5$, $X = 24$ miles, the total time of flow was 3.51×10^4 s and $2t_{\frac{1}{2}} = 120$ s, which is equivalent to 13200 cm. Hence

$$K = \frac{(6600)^2}{4(0.693)(3.51 \times 10^4)} = 4.48 \times 10^2, \text{ and from figure 2, } U/v_* = 23.5 \text{ so that}$$

$$\frac{K}{av_*} = \frac{4.48 \times 10^2}{(4 \times 2.54) 110} (23.5) = \mathbf{9.44.} \quad (9.2)$$

For the 20 in. line from San Pablo to Richmond the diffusion coefficient was given by Hull & Kent as 2.04 ft./s. In c.g.s. units this is 1890 cm²/s. In this test $U = 4.51$ ft/s or 1372 cm/s and $R = 1.0 \times 10^5$; in figure 2 this corresponds to $U/v_* = 21.0$, hence

$$\frac{K}{av_*} = \frac{(1890)(21.0)}{(10 \times 2.54)(1372)} = \mathbf{11.4.} \quad (9.3)$$

10. PREDICTED DISTRIBUTION OF CONCENTRATION WHEN ONE FLUID FOLLOWS ANOTHER IN A PIPE

It will be supposed that the fluids have the same, or at any rate comparable, viscosities, and that a long straight pipe is initially full of fluid *A*. At time $t = 0$ another fluid *B* enters the tube at one end $X = 0$, and pushes the fluid *A* along the tube. There is a length in which both fluids are mixed. The problem of determining the length of the zone of mixture is one which can be treated by the use of the virtual diffusion coefficient K provided the liquids are miscible and do not differ greatly in density or viscosity.

If C is the proportion of fluid *B* in the mixture at any point, the equation for diffusion of C is

$$\left[\frac{\partial C}{\partial t} \right]_1 = K \frac{\partial^2 C}{\partial x_1^2}, \quad (10.1)$$

where x_1 is measured relative to axes which move with the mean speed of flow U , and $[\partial C/\partial t]_1$ is the time rate of change of C at points which move with velocity U . The appropriate solution of (10.1) is

$$C = \frac{1}{2} - \frac{1}{2} \operatorname{erf} \left(\frac{1}{2} x_1 K^{\frac{1}{2}} t^{-\frac{1}{2}} \right), \quad (10.2)$$

where

$$\operatorname{erf}(z) = \frac{2}{\sqrt{\pi}} \int_0^z e^{-z^2} dz.$$

If a length S be defined such that it includes all the points where $0.99 > C > 0.01$ it is found from (10.2) that

$$\operatorname{erf} \left(\frac{1}{4} S K^{-\frac{1}{2}} t^{-\frac{1}{2}} \right) = 0.98.$$

From tables $\operatorname{erf}(1.645) = 0.98$,

so that $S = 4K^{\frac{1}{2}} t^{\frac{1}{2}} (1.645)$.

Inserting the value of K from (4.19)

$$S^2 = (6.58)^2 (10.1) av_* t,$$

and since $t = X/U$,

$$S^2 = 437aX \left(\frac{v_*}{U} \right). \quad (10.3)$$

Thus in a given pipe at a given speed $S \propto X^{\frac{1}{2}}$.

Comparison with experiments

Smith & Schulze (1948) describe experiments with a 2 in. pipe which was not in a straight length but was wound round into a large number of coils. They summarized their experimental results in the empirical formula

$$S = (1.075R^{-0.87} + 0.55) X^{0.62}. \quad (10.4)$$

In Smith & Schulze's formula (10.4) S and X are measured in feet. R is the Reynolds number and is non-dimensional. This expression is derived from experiments on the flow in a 2 in. pipe and is not therefore applicable to pipes of other sizes. Smith & Schulze did however apply it to larger pipes and found good agreement in some cases. This is very surprising in view of the fact that the theoretical expression (4.19) shows that for a given Reynolds number, i.e. a given U/v_* , S should be proportional to $a^{\frac{1}{2}}$. The empirical formula (10.4) might therefore be expected to underestimate S for all the four experimental pipes (6, 8, 10, 12 in. diameter) for which they were able to obtain measurements. In fact (10.4) overestimates S for the 6 in. pipe and underestimates it for the 12 in. pipe. It seems to me that the reason is that the experiments made with a coiled 2 in. pipe with two pumps in the circuit would be expected to introduce far greater dispersion than a straight pipe of the same diameter.

The experimental results given by Smith & Schulze are quoted in the last column, 10, of their tables (figures 14, 15, 16, 17, Smith & Schulze 1948). They are quoted in a unit tabled as 'Bbl'. This appears to be 'barrels of oil contained in the length S of the pipe'. To compare experimental results with formulae (9.3) and (9.4) it is necessary to convert the figures given in terms of 'Bbl' to S in feet. This can be done without knowledge of the exact volume of the unit 'Bbl' because in column 8 of Smith & Schulze's tables the value of S calculated by their empirical formula (10.4) is given, and in column 9 these are converted by a constant factor into 'Bbl'. Thus the observed values of S can be calculated by multiplying the figures given as 'observed Bbl' in column 10 by the 'calculated' value of S given in column 8 and dividing by the 'calculated' numbers given in column 9 in terms of 'Bbl'. The figures in the last columns of table 5 of the present paper and headed 'observed', were obtained in this way.

The comparison between Smith & Schulze's measurements, the empirical formula (10.4), and the present theoretical formula (10.3), is given in table 5. It will be seen that for all except the longest runs, 1 million feet or more, the purely theoretical formula, derived *a priori*, gives better agreement with observation than the empirical one based on experiments on dispersion in a 2 in. pipe. As was to be

The dispersion of matter in turbulent flow through a pipe 467

expected the empirical formula, which does not allow for variation in pipe diameter except in so far as R varies, underestimates S for large pipes. That it actually overestimates the dispersion in the case of the 6 in. pipe must be due to the fact that the empirical formula (10.4) is based on experiments with a coiled pipe. The method of analysis used in the present paper would lead one to expect that the dispersion in a coiled pipe may be much greater than in a straight pipe and the experiment described in §8 shows that this is in fact the case.

TABLE 5. COMPARISON BETWEEN SMITH & SCHULZE'S DATA
AND THE PRESENT THEORY

S is distance in feet along pipe of region where concentration of both components is greater than 1%.

6 in. pipe (figure 14, Smith & Schulze) gasolene—gasolene

X (ft.)	$10^{-4}R$	U/v_*	S	S	S	
			empirical eq. (10.4)	theory eq. (10.3)	observed	
299060	2.39	17.9	1787	1365	1150	1270*
	4.9	19.5	1593	1310	—	1050*
	7.4	20.4	1525	1280	920	950*
	10.1	21.1	1489	1228	—	780*
	24.6	23.0	1425	1200	810	—
	24.5	23.0	1428	1270	920	—

8 in. pipe (figure 15, Smith & Schulze)

X (ft.)	$10^{-5}R$	U/v_*	S	S	S
			eq. (10.4)	eq. (10.3)	observed
291298	2.19	22.9	1416	1370	1410
606514	2.19	22.9	2205	1975	2070
895488	2.19	22.9	2825	2400	2520
1168147	2.19	22.5	3342	2740	3220
1168147	2.24	23.0	3339	2740	3210

12 in. pipe (figure 17, Smith & Schulze)

X (ft.)	$10^{-5}R$	U/v_*	S	S	S
			eq. (10.4)	eq. (10.3)	observed
322186	5.90	25.4	1458	1670	1770
661109	5.76	25.4	2292	2390	2425
1018301	5.84	25.4	2982	2970	2890
1402896	5.91	25.4	3638	3480	3505
1726085	5.79	25.4	4560	3870	3895
2033803	5.79	25.4	4555	4190	4360
2279538	4.50	24.6	4980	4340	4670

* Colorimetric method.

The measurements described in §8 were mostly made by Dr T. H. Ellison, who designed the apparatus for recording the changes in conductivity. Without his assistance this part of the work would not have been done and I wish to express my thanks to him.

REFERENCES

- Allen, C. M. & Taylor, E. A. 1923 *Trans. Amer. Soc. Mech. Engrs*, **45**, 285.
 Goldstein, S. 1938 *Modern developments in fluid mechanics*. Oxford: Clarendon Press.
 Hull, D. E. & Kent, J. W. 1952 *Industr. Engng Chem.* **44**, 2745.
 Nikuradse, J. 1932 *Ver. dtsh. Ing. Forschungsheft*, p. 356.
 Smith, S. S. & Schulze, R. K. 1948 *Petrol. Engr*, **19**, 94; **20**, 330.
 Stanton, T. E. & Pannell, J. R. 1914 *Phil. Trans. A*, **214**, 199.
 Taylor, Sir Geoffrey 1922 *Proc. Lond. Math. Soc.* (2), **20**, 196.
 Taylor, Sir Geoffrey 1953*a* *Proc. Roy. Soc. A*, **219**, 186.
 Taylor, Sir Geoffrey 1953*b* *Appl. Mech. Rev.* p. 265.
 Worster, R. C. 1952 British Hydromechanics Research Ass. Publication no. T.N. 443.

A study of gauge-invariant non-local interactions

BY M. CHRÉTIEN* AND R. E. PEIERLS, F.R.S.

Department of Mathematical Physics, University of Birmingham

(Received 19 January 1954)

The paper investigates the possibility of introducing 'non-local' interactions, i.e. interactions represented by four-dimensional integral operations, in order to eliminate divergences in the quantum theory of interacting fields. In particular, a type of equation is discussed which preserves all the required invariance properties, including gauge invariance and macroscopic causality. It turns out that equations of this type still give divergent results. The origin of these divergences is discussed, and it is shown that if there is any way of formulating a finite theory it would have to be very different from the one investigated here.

1. INTRODUCTION

By 'theories with non-local interactions' we shall here understand equations in which the point interactions of the usual, 'local', field theories are replaced by integral expressions (representing in some sense a finite space-time extension of elementary particles) in order to avoid singularities. They are distinct from attempts to introduce internal variables for associating more than one type of particle with the same field (Yukawa 1949, 1950), though there are some points of contact between these approaches (Bloch 1950).

The idea of non-local interactions goes back to Lorentz's picture of a finite electron radius. The first suggestion of making such interactions Lorentz-invariant was made by Wataghin (1934), and the classical (i.e. non-quantum) aspects of the problem were studied by McManus (1948) and others. These attempts were made at a time when the infinities appeared to prevent further progress. Since then the development of the idea of renormalization by Schwinger, Feynman and others has demonstrated that the present formalism can be made to give unambiguous finite answers which, in the electromagnetic case, are in excellent agreement with observation.

* Now at Pupin Physics Laboratory, Columbia University.

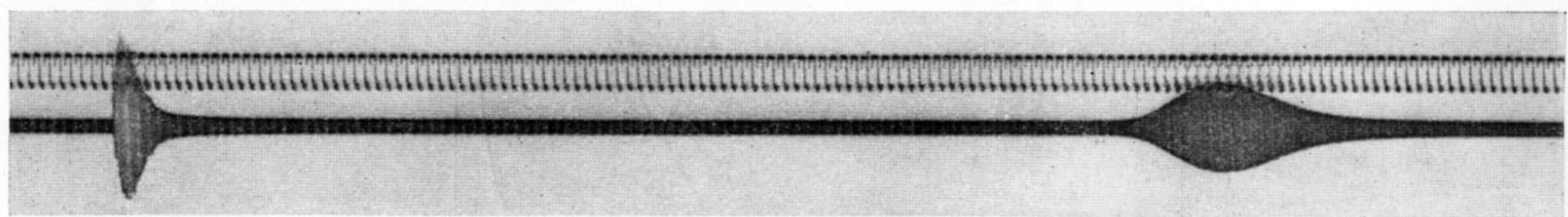

$X = 15$ cm

$X = 468$ cm

FIGURE 5. Record showing pulse at $X = 15$ and at 468 cm.

1.4 1.6 1.71 1.8 2.0 sec

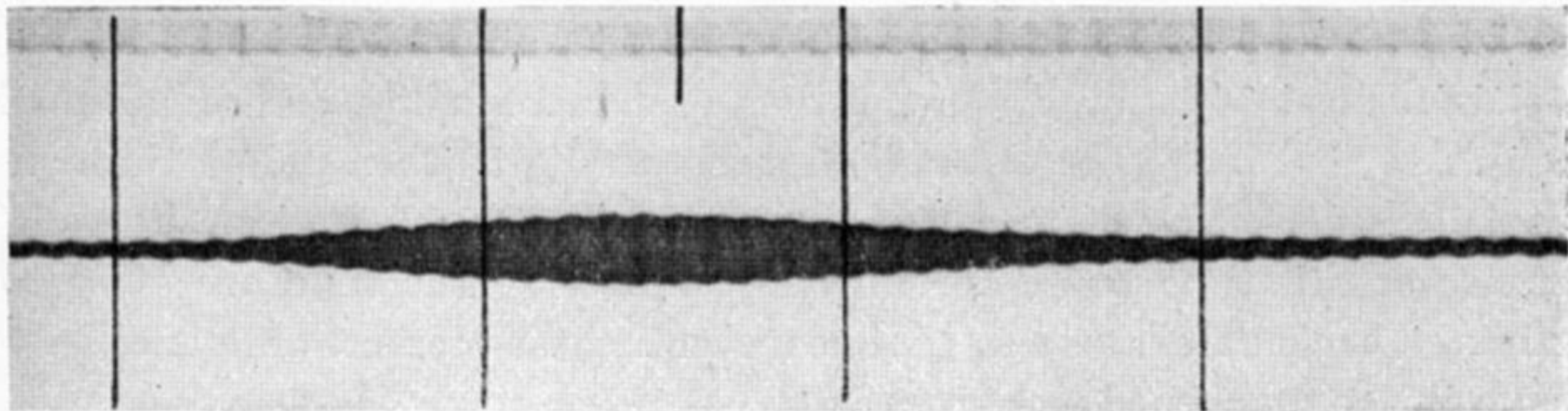

FIGURE 9. Record of pulse in a very rough pipe, $U = 146$ cm/s.